

Flexy Compact Ambient Unit on cupboard (4 GN) with one stainless steel tray slider

ITEM # _____

MODEL # _____

NAME # _____

SIS # _____

AIA # _____

322110 (F00N4AF00W)

 Ambient Unit on cupboard
 (4 GN) with one stainless
 steel tray slider, H=900mm

Short Form Specification

Item No. _____

Compact design, ideal for space saving environments. Stainless steel tubular tray slider on customer side. Top provides ample displaying or workspace surface. Unit mounted on 150 mm high feet. Soft closing doors on operator side. Underneath ambient cupboard with doors. Sturdy body construction with laminated panelings on 4 sides.

Main Features

- CB and CE certified by a third party notified body.
- Tray slider in tubular stainless steel is installed on the customer side and it can also be folded down to facilitate passage of the units through doorways.
- Ideal for servery lines with an operator.
- Unit mounted on 150 mm high feet.
- Soft closing doors on operator side.
- Available options with online configurator: colors, tray sliders, overshelves, feet/wheels with desired diameter, height 750mm for kids.
- Top provides ample displaying or workspace surface.
- Optional plinth can be installed to cover the feet or the wheels.
- Perfect compact design makes it ideal for space saving environments.
- Food introduced at the correct temperature maintains its core temperature according to Afnor Standards.
- Available dimensions: 1, 2, 3, 4 GN.
- Thanks to the sleek, minimalist glass structure, food and dust does not get trapped and the cleaning is made easier.

Construction

- Top in AISI 304.
- Sturdy construction with laminated panelings on 4 sides.

APPROVAL: _____

Front

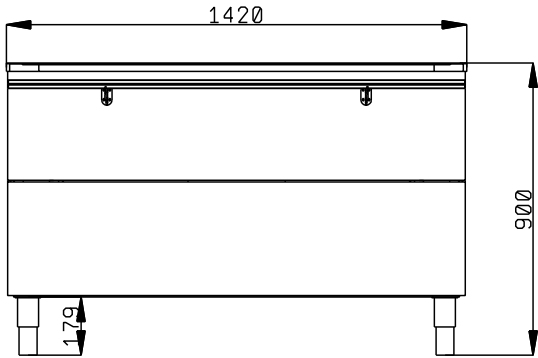

Side

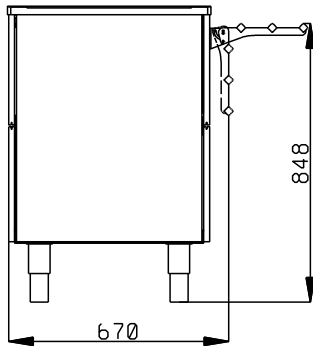

Top

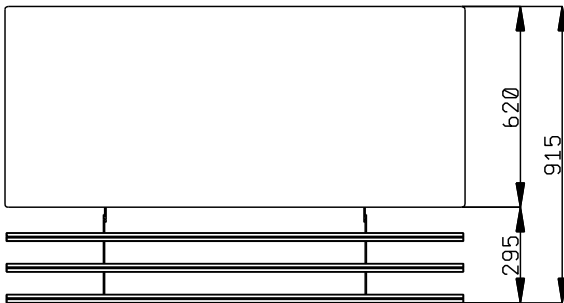

Key Information:

N° of doors:	2
322110 (F00N4AF00W)	
External dimensions, Width:	1420 mm
External dimensions, Depth:	915 mm
External dimensions, Height:	900 mm
Net weight:	88 kg
Shipping height:	930 mm
Shipping width:	710 mm
Shipping depth:	1440 mm